

USER MANUAL

BABY HAMMOCK



moonboon
designed for better sleep

CONTENTS

2	Instructions video	9	Assembly
3	Important information	10	Height
6	What is included	10	Placement of the child
7	Mounting options	11	Cleaning
8	Overview		

INSTRUCTIONS VIDEO

Moonboon has developed a series of videos to show you easily and quickly how to assemble and mount your Moonboon product.

The instructional videos are a supplement to the user manual. It is critical that you read this user manual.

Scan the QR code with your smartphone or use this link to see the videos:



moonboon.com/pages/videos



IMPORTANT! READ CAREFULLY AND KEEP FOR FUTURE REFERENCE

⚠ WARNINGS

- Do not use this product without reading the instructions first.
- Stop using the product as soon as the child can sit or kneel or pull itself up.
- Placing additional items in the product may cause suffocation.
- Do not place the product close to another product, which could present a danger of suffocation or strangulation, e.g. strings, blind/curtain cords, etc.
- Do not use more than one mattress in the product.
- Only use the mattress sold with this product, do not add a second mattress on this one, suffocation hazards.

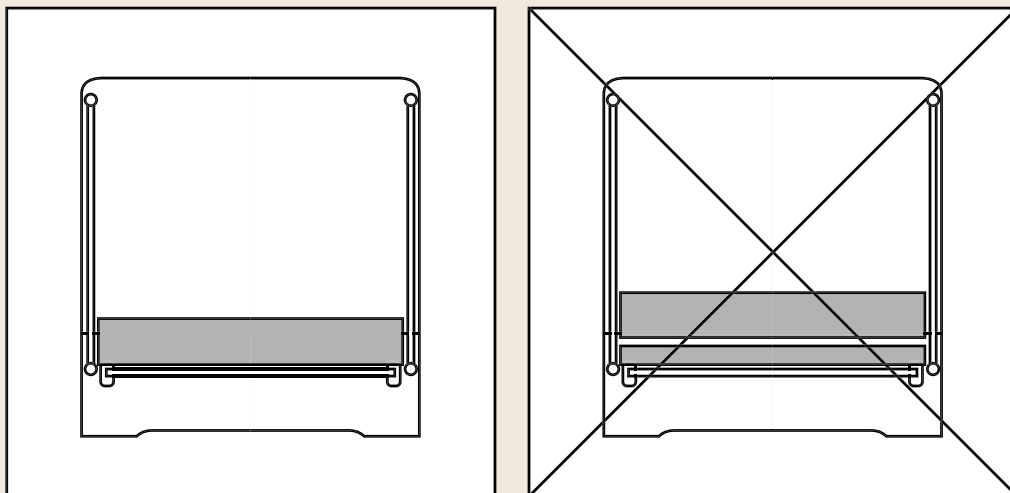

IMPORTANT INFORMATION

- When the baby hammock is used with the tripod stand, make sure the tripod stand is placed on a horizontal floor.
- Young children should not be allowed to play unsupervised in the vicinity of the baby hammock.
- Check that the baby hammock is mounted and all elements are securely fixated according to the assembly instructions when the child is left unattended. We always recommend that you stay close to the baby hammock when your child rests in it.
- Please ensure all assembly fittings are mounted and tightened properly and be aware that no parts are loose, a child could trap parts of the body or clothing (e.g. strings, necklaces, ribbons for babies' dummies, etc.), which would pose a risk of strangulation.
- A mattress is included with the baby hammock. For safety and compatibility, only replace it with a Moonboon mattress of the same size and shape.
- Be aware of the risk of burning cigarettes, open fires and other sources of strong heat, such as electric bar fires, gas fires, etc. in the near vicinity of the baby hammock.
- The baby hammock must remain in a horizontal position when in use. Place the baby in the center of the baby hammock and position the baby's head slightly higher than the feet. Always check that your baby is placed in the center of the baby hammock to avoid instability.
- **DO NOT** use the baby hammock if any parts are missing, damaged, or broken. Contact Moonboon for replacement parts and instructional literature if needed. **DO NOT** substitute parts.
- Never use the baby hammock as a swing or a toy. The child may get injured if the amplitude of the swing is excessive.

Continued on the next page...

- Suspended baby hammocks may pose risks to other children.
- Other children may pose additional risks (e.g. by swinging the baby hammock excessively).
- Uneven surfaces can cause instability of the product.
- Place the suspended baby hammock in such a way that there is no risk of swing impact (e.g. no risk of the child hitting the baby hammock, or the baby hammock hitting other furniture).
- Always use the accompanying plastic parts provided with the baby hammock. All metal-to-metal connections must be covered with the plastic parts. This is to avoid the risk of metal fragments coming loose from the metal-to-metal connecting parts. This also includes the ceiling hook.
- The cross pin should be positioned horizontally or as close to horizontal as possible. It is important to tie the baby hammock ties around both the cross pin and the fabric to keep the cross pin securely in place.
- Do not swaddle or wrap a blanket around your baby while they are placed in the baby hammock.
- Before each use, check that the safety strap is properly attached to the spring. The strap should pass through the spring and be secured to the "eye" at each end of the spring.
- Before each use, ensure that the four fabric ties of the baby hammock and the cross pin are correctly and securely tied.
- Before each use, check that all buttons are properly fastened and secure.
- Before each use, inspect the baby hammock and its mounting to ensure they meet all safety requirements.
- Before each use ensure that the baby hammock does not touch the floor when it bounces. Read the section about **HEIGHT**.

WHAT IS INCLUDED

- A 1x Baby hammock in 100% organic cotton
- B 1x Kapok mattress
- C 1x Wooden cross pin
- D 1x Spring with a swivel snap and safety strap
- E 1x Fabric spring cover



MOUNTING OPTIONS

The baby hammock can be installed with the Moonboon tripods stand, door frame clamp or with the Moonboon Mounting Kit. No matter how you choose to install the baby hammock, you should always place it somewhere that does not have a draft and at a safe distance from the nearest wall, furniture, or the like. See further instructions in the section about **HEIGHT**.

TRIPOD STAND

You should only use the Moonboon tripod stand, developed to carry the baby hammock. Place the tripod stand on a solid floor that is not crooked. Read your user manual for the tripod stand carefully.

DOOR FRAME CLAMP

It is possible to install the baby hammock with a door frame clamp to hang it in a doorway. We recommend you use Moonboon's door frame clamp, which can hold a load of 20 kg.

- The door frame on which you mount the door frame clamp should only be 25 cm wide as a maximum.
- The door frame clamp must be firmly attached to both sides of the wall.
- No wires must obstruct the door frame.

Read your user manual for the door frame clamp carefully.

MOUNTING KIT

If you choose to install the baby hammock from a hook in the ceiling, we always recommend you use Moonboon's Mounting Kit, which includes a stainless steel ceiling hook and a hardwearing mounting strap in cotton and nylon. If you choose to use another hook, you must always ensure that the hook is strong enough to carry the weight of the baby hammock and the child.

Please note

Never push the baby hammock back and forth or sideways, and do not use it as a swing.

Please note

We recommend you use Moonboon's Mounting Kit, developed explicitly for suspension from the ceiling. If you use other methods to suspend from the ceiling, such as a hook, it must be made from stainless steel without a coating. The same applies if you choose to use a metal chain.

OVERVIEW

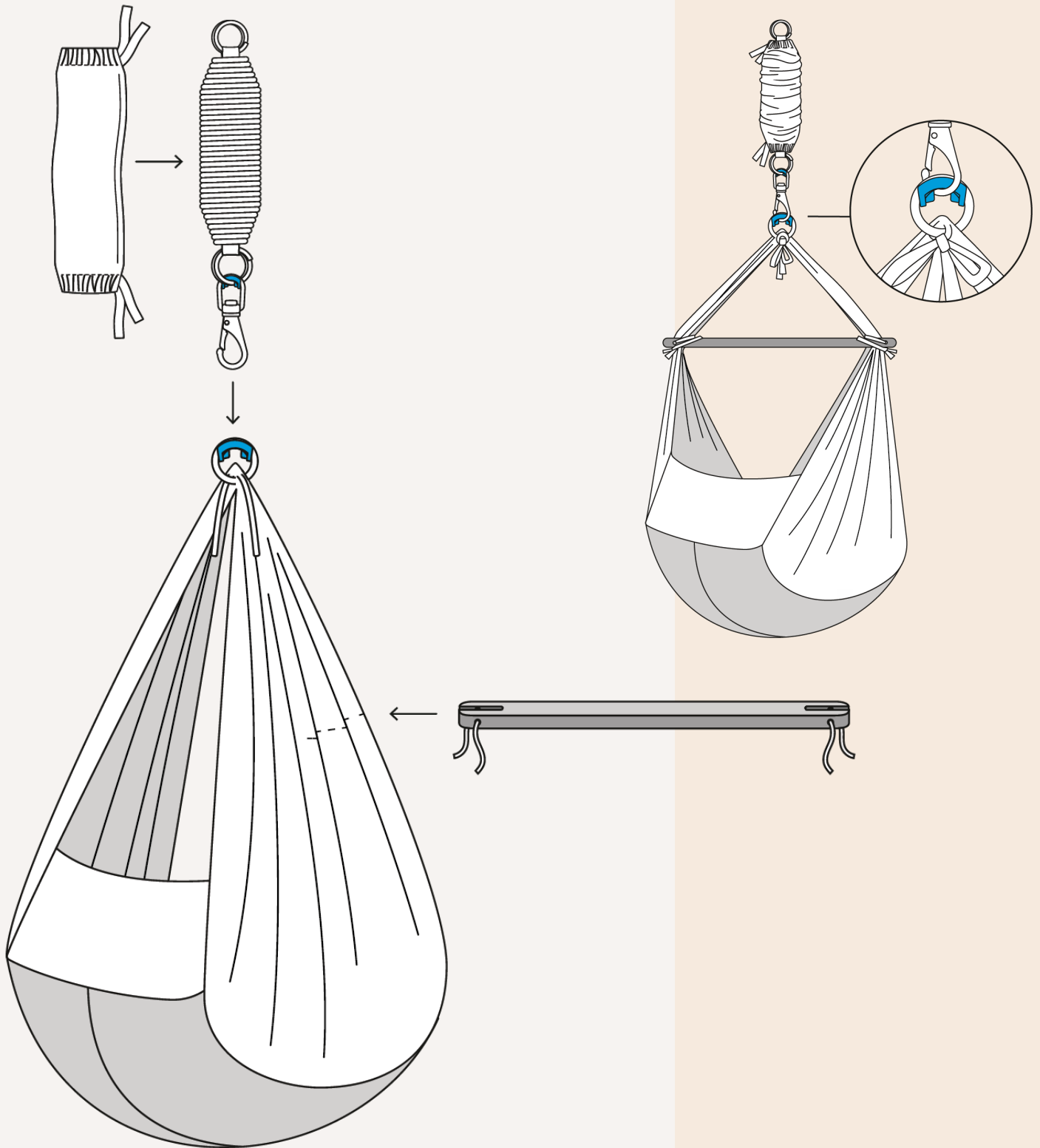

ASSEMBLY

1 PREPARE THE MOUNTING

Set up your chosen mounting method: tripod stand, door frame clamp, or Mounting Kit. If using a cradle bouncer, install it first (refer to its manual).

2 ATTACH THE SPRING COVER

Slide the cover over the spring and tie it at both ends. Stretch the spring manually to distribute the cover evenly.

3 HANG THE SPRING

Hang the spring using the carabiner provided in the package. Note that the spring swivel carabiner must point down as shown in the illustration on the previous page.

4 HANG THE BABY HAMMOCK

Locate the metal ring at the top of the baby hammock. Each side has two ties. Securely tie them in a bow around the metal ring on both sides.

5 MOUNT THE CROSS PIN

Loosen the string from one of the openings at the ends of the cross pin. Position the cross pin in place, at the stitched line, ensuring it hangs horizontally. Guide the loose ends of the string back through the other holes in the cross pin. Tie the string securely around both the cross pin and the fabric.

The baby hammock is now ready for use. Please refer to the **HEIGHT** section for additional details.

4

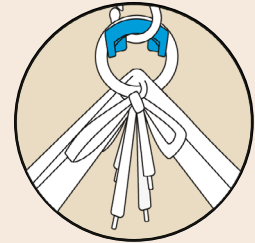

5

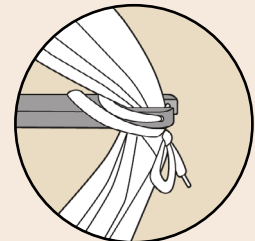
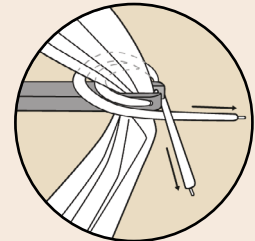
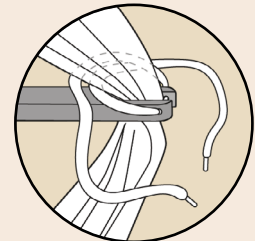
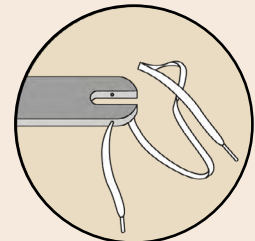
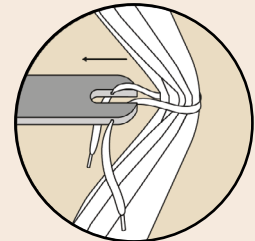

HEIGHT

It is essential that the baby hammock does not touch the floor during operation. Before using the baby hammock, perform two tests to ensure that the baby hammock does not touch the floor.

FIRST TEST: EMPTY BABY HAMMOCK

Mount the baby hammock as instructed and manually stretch the spring as much as you can. Pull on the spring until you feel the safety strap (the nylon strap inside the spring) preventing any further expansion.

When the spring is fully extended, space must remain between the bottom of the baby hammock and the floor.

SECOND TEST: CHILD IN THE BABY HAMMOCK

Now place the child in the baby hammock and repeat the test described above: Stretch out the spring until you feel the safety strap keeping it from stretching further.

Here, too, space must remain between the bottom of the baby hammock and the floor.

PLACEMENT OF THE CHILD

- Place the baby in the middle of the baby hammock such that the head is elevated slightly as compared to the feet.
- The child's head goes in the end opposite the buttons. Place a larger child as close to the head end assembly of the baby hammock as possible.
- Make sure that the cross pin is horizontal as it keeps the shape of the baby hammock.

Please note

Follow these instructions and perform the tests regularly as your child grows and becomes heavier. That is how you ensure that the baby hammock never touches the floor.

Please note

It is important to ensure that duvets, blankets, wraps, and the like are never placed on top of baby's head. If using a cover, make sure it is firmly tucked in under baby's arms and come up no higher than the chest.

CLEANING

BABY HAMMOCK

The baby hammock may be washed by hand at just over 100°F / 40°C. We do not recommend machine washing as the metal ring of the baby hammock may cause damage to your washing machine and to the baby hammock.

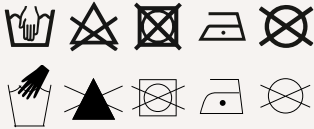

Wash by hand at 40 degrees | Do not bleach | Do not tumble dry | Iron at low heat | Do not dry clean.

MATTRESS

The kapok fibers in the mattress benefit from being aired outdoors about once a month, but the mattress cannot be washed.

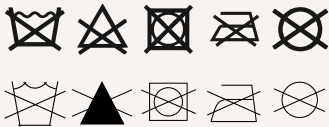

Wipe with damp cloth and let air | Do not bleach | Do not tumble dry | Do not iron | Do not dry clean.





Updated 02.2025

Produced by Moonboon International ApS
Lindgreens Allé 9, 1 tv, 2300 Copenhagen Denmark

hello@moonboon.com
www.moonboon.com
+45 89877575

UK: Unit 142091, PO Box 7169
Poole, BH15 9EL, United Kingdom

 moonboon_official  moonboon_official  moonboon.com